

Vista

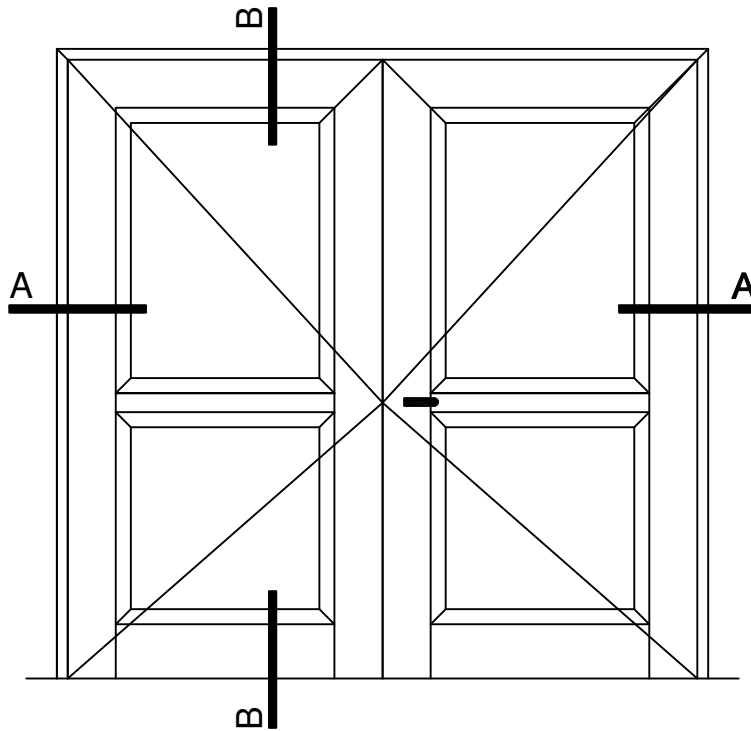

B-B Corte Vertical

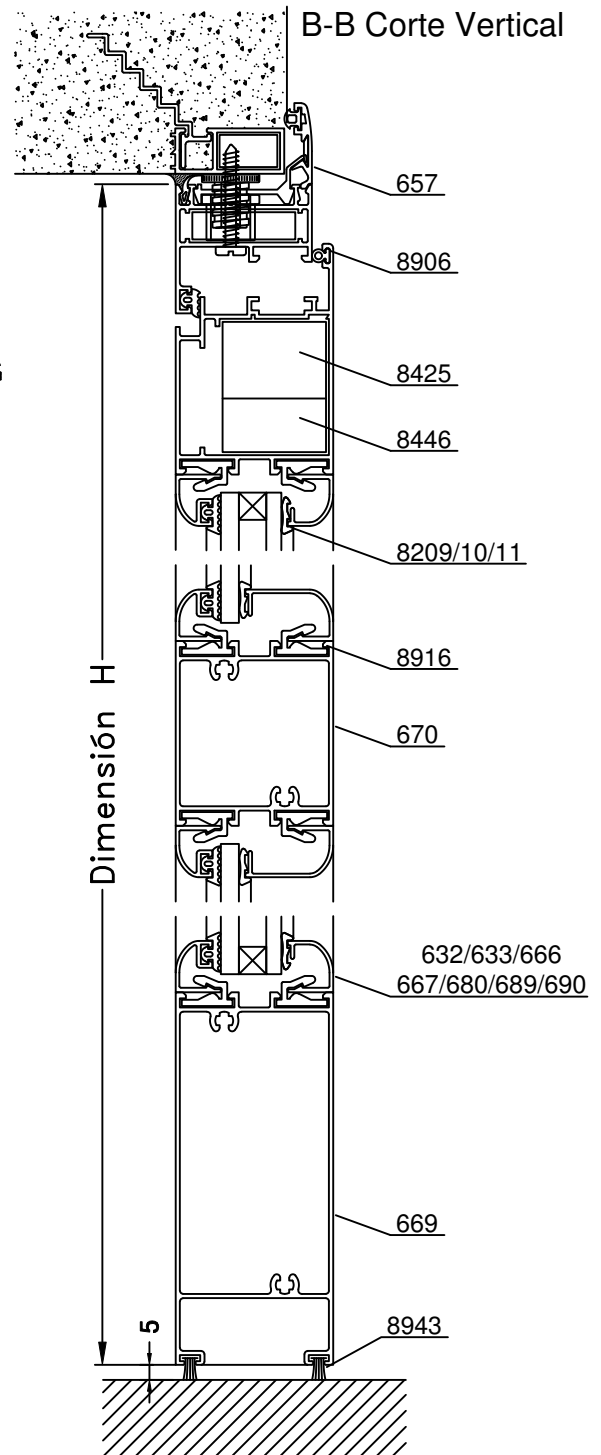



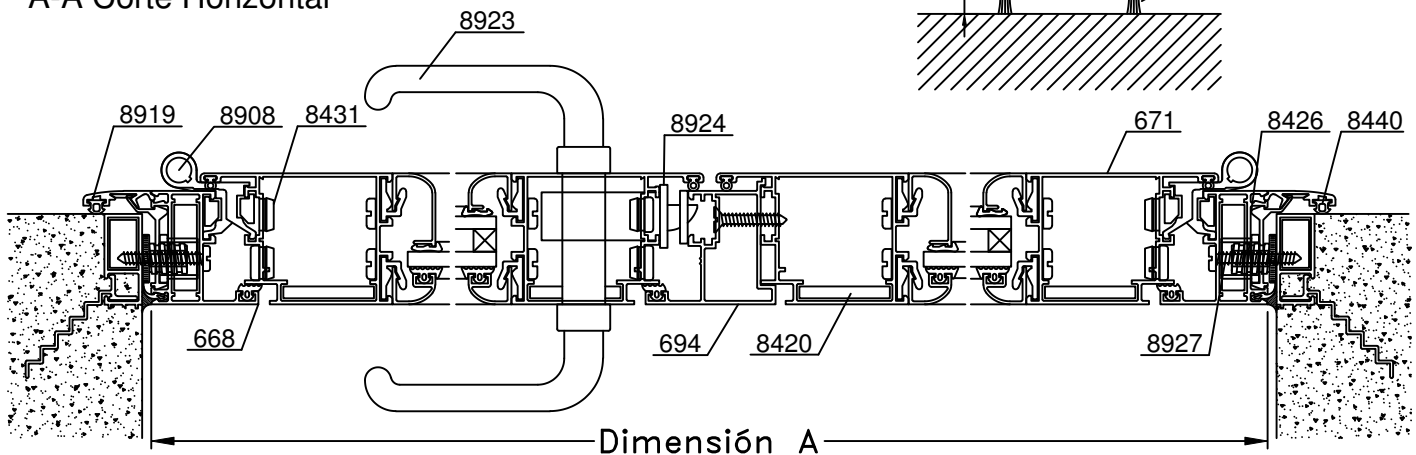



A-A Corte Horizontal



















Escala 1:2.5

Tolerancia en Peso +/- 10%

20-01-12 **DELTA.41**

Dimensiones de Corte Puerta de Rebatir de 2 Hojas				Sin Travesaño			Con 1 Travesaño		
Función	Código	Peso Kg/m	Forma	Cant.	Largo	Corte	Cant.	Largo	Corte
Marco	668	0,66		1	A	45° 45°	1	A	45° 45°
				2	H	45° 90°	2	H	45° 90°
Parante	671	0,94		2	A/2-23	45° 45°	2	A/2-23	45° 45°
				4	H-25	45° 90°	4	H-25	45° 90°
Zócalo	669	1,63		2	A/2-175	90° 90°	2	A/2-175	90° 90°
Travesaño	670	1,01		-	-	-	1	A/2-175	90° 90°
Inversor	694	0,80		1	H-53	90° 90°	1	H-53	90° 90°
Contravidrio Interior	Contravidrios Curvos	-	-	4	A/2-175	45° 45°	8	A/2-175	45° 45°
				4	H-223	45° 45°	8	H-223	45° 45°
	Contravidrios Rectos	-	-	4	A/2-175	90° 90°	8	A/2-175	90° 90°
				4	H-257	90° 90°	8	H-257	90° 90°
Contravidrio Exterior	672	0,18		4	A/2-175	45° 45°	8	A/2-175	45° 45°
				4	H-223	45° 45°	8	H-223	45° 45°

Detalle de Accesorios Puerta de Rebatir de 2 Hojas			
Código	Descripción	Forma	Cantidad
8423	Escuadra de Armado E-69		2 Unidades
8425	Escuadra Parante E-70		4 Unidades
8446	Escuadra Suplementaria 40.5 mm. E-67		4 Unidades
8419	Tornillo Parker 12 x 1½ T-20		8 Unidades + 8U. x trav.
8431	Tapa Tornillo T-100		8 Unidades + 8U. x trav.
8916	Clip Contravidrio T-96		s/m
8913	Burlete de Acristalamiento B-68		2A + 2H + 2A x trav.
8209	Cuña Chica		2A + 2H + 2A x trav.
8210	Cuña Mediana		
8211	Cuña Grande		
8906	Burlete AEL Europeo		1A + 4H
8914	Burlete de Hermeticidad B-67		1A + 3H
8923	Manija Prima H-93		1 Unidad
8924	Cerradura H-51 (Kallay 5006)		1 Unidad
8920	Bisagra H-62 de 3 piezas con Kit		6 Unidades
8943	Felpa de 7x6 con Fin Seal		2A
8420	Porta Felpa T-99		4 Unidades
9124	Pasador H-42		2 Unidades
8451	Tapón Encuentro 2 Hojas T-98		2 Unidades

- Medidas en milímetros
- Dimensiones de Corte de Premarco y Contramarco, en página 55

- Detalle de Accesorios para Fijación, Premarco y Contramarco en página 55
- s/m : según medida