

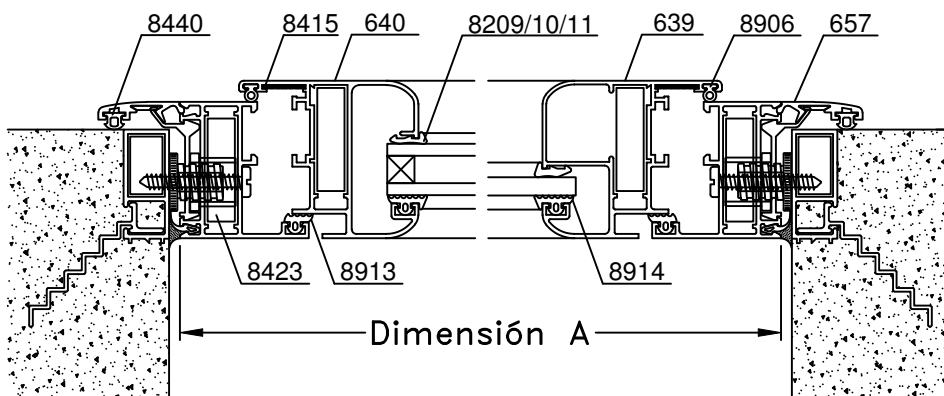

A-A Corte Horizontal









Escala 1:2.5
Tolerancia en Peso +/- 10%

20-01-12 **DELTA.33**

Dimensiones de Corte Ventana Banderola						
Función	Código	Peso Kg/m	Forma	Cant.	Largo	Corte
Marco	668	0,66		2	A	45° 45°
				2	H	45° 45°
Hoja	695	0,86	-	2	A-39	45° 45°
	696	0,90		2	H-39	45° 45°
	639	0,99	-	2	A-39	45° 45°
	640	1,00		2	H-39	45° 45°
Contravidrio	Contravidrios Curvos	-	-	2	A-123	45° 45°
				2	H-123	45° 45°
	Contravidrios Rectos	-	-	2	A-123	90° 90°
				2	H-157	90° 90°

- Medidas en milímetros

- Dimensiones de Corte de Premarco y Contramarco, en página 55

Detalle de Accesorios Ventana Banderola			
Código	Descripción	Forma	Cantidad
8423	Escuadra de Armado E-69		8 Unidades
8415	Escuadra Alineación de Hoja (a)	-	8 Unidades
8916	Clip Contravidrio T-96		s/m
8913	Burlete de Acristalamiento B-68		2A + 2H
8209	Cuña Chica		2A + 2H
8210	Cuña Mediana		
8211	Cuña Grande		
8906	Burlete AEL Europeo		2A + 2H
8914	Burlete de Hermeticidad B-67		2A + 2H
8904	Cierre Banderola H-52		1 Unidad
8443	Brazo Sostén H-53		1 Par
8908	Bisagra H-61 de 2 piezas con Kit		2 Unidades
8366	Tapa Desague T-69		2 Unidades

- Detalle de Accesorios para Fijación, Premarco y Contramarco en página 55

- s/m : según medida

(*) En hojas de medidas superiores a 800mm de ancho se aconseja colocar 2 cierres

- a: Escuadra de alineación para Hoja 639 y 640