

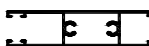











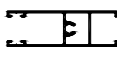







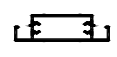

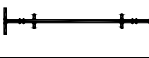



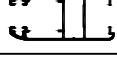
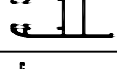









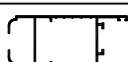
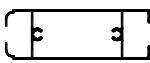
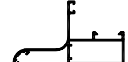

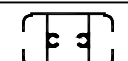
CODIGO	PESO (Kg/m)	T. x P.	DESCRIPCION	FORMA	PAG
5	0,81	4	Zócalo Alto para Puerta Corrediza		6
20	0,68	4	Hoja V/S para Ventana Banderola, Ventana de Rebatir y Oscilo-Batiente		7
21	0,65	4	Hoja DVH para Ventana Banderola, Ventana de Rebatir y Oscilo-Batiente		7
22	0,23	16	Porta Felpa Zócalo		8
23	0,50	8	Zócalo para Ventana Corrediza - Línea Combinada		6
26	0,27	10	Encuentro Central para Ventana y Puerta Corrediza - Línea Combinada		6
27	0,18	20	Encuentro Central para 4 Hojas con Perfil 481 o 482 de Parante Lateral		6
43	1,17	2	Columna a 45°		14
70 (a)	0,71	4	Marco PF / VB/ VR/ VPBdE		5
75 (a)	0,64	4	Marco PF / VB/ VR/ VPBdE		5
109	0,44	6	Mosquitero para Ventana y Puerta Corrediza, y Puerta Mosquitero		13
129	0,12	20	Tapa Doble Compensador		10
190	0,45	8	Travesaño de Mosquitero		13
200	0,15	20	Bota Agua		12
380	0,22	20	Contravidrio		12
453	0,45	8	Acople		15
455	1,18	2	Columna a 90°		14
470	0,27	8	Perimetral de Vidrio Repartido		13
471	0,36	8	Central de Vidrio Repartido		13
480	0,58	6	Parante Central para Ventana y Puerta Corrediza Opción "C"		6
481	0,70	4	Hoja para Ventana y Puerta Corrediza - Línea Combinada		6
482	0,76	4	Hoja para Ventana y Puerta Corrediza con D.V.H		6
485	0,77	4	Marco Ventana Desplazable		9

Referencia (a): Largo de la Barra 6150 milímetros

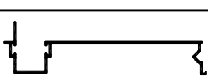













T. x P.: Tiras por Paquete

CODIGO	PESO (Kg/m)	T. x P.	DESCRIPCION	FORMA	PAG
487 (a)	0,17	12	Contramarco Curvo Coplanar		11
488	0,96	4	Marco para Ventana y Puerta Corrediza		5
489 (b)	1,06	4	Marco con Contramarco para Ventana y Puerta Corrediza		5
505	0,97	2	Marco para Ventana Guillotina		10
506	0,69	6	Zócalo y Cabezal de Hoja para Ventana Guillotina		10
507	0,56	6	Hoja para Ventana Guillotina		10
508	0,17	20	Contravidrio para Ventana Guillotina		10
509	0,14	20	Tapa Compensador		10
510	0,15	20	Contravidrio para Ventana Guillotina		10
514 (a)	0,91	3	Hoja para Puerta de Rebatir		8
515	1,30	3	Zócalo para Puerta de Rebatir		8
516 (a)	0,76	2	Marco para Ventana Banderola, Ventana y Puerta de Rebatir y Oscilo-Batiente		7
518	1,00	4	Refuerzo de Parante		15
523	0,17	20	Contravidrio		12
552	0,86	3	Travesaño para Puerta de Rebatir		7
553	0,21	16	Adaptador para D.V.H.		15
570	0,20	16	Perimetral de Vidrio Repartido		13
571	0,27	8	Central de Vidrio Repartido		13
648 (a)	0,50	5	Premarco de 55 mm		11
684 (a)	0,89	4	Guía de Cortina Regulable		16
698	0,20	20	Contravidrio		12
699	0,13	20	Contravidrio		12
702	0,81	4	Inversor de Hoja		7

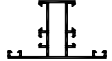
Referencia (a): Largo de la Barra 6150 milímetros

T. x P.: Tiras por Paquete

Referencia (b): Largo de la Barra 6300 milímetros

CODIGO	PESO (Kg/m)	T. x P.	DESCRIPCION	FORMA	PAG
703	0,16	20	Perfil Parte Omega de Aluminio Anodizado		8
705	0,16	20	Contra vidrio		12
706	0,20	20	Contra vidrio		12
716 (a)	0,52	6	Tapacinta		15
722 (a)	0,49	8	Guía de Cortina Común		16
725	0,26	10	Tope Inferior Umbral Transitable para Puerta de Rebatir		9
726	0,39	10	Umbral Transitable para Puerta de Rebatir		9
731 (a)	1,14	3	Parante		8
732	1,44	2	Zócalo		8
733	0,81	4	Travesaño		7
737	0,83	4	Hoja Ventana Desplazable		9
750 (a)	0,28	10	Soporte Tapacinta		15
877	0,30	20	Contra vidrio Recto de 22 mm.		12
878	0,25	20	Contra vidrio Recto de 15,2 mm.		12
879	0,21	20	Contra vidrio Recto de 8 mm.		12
986	1,06	2	Columna Curva a 90°		15

Referencia (a): Largo de la Barra 6150 milímetros

T. x P.: Tiras por Paquete

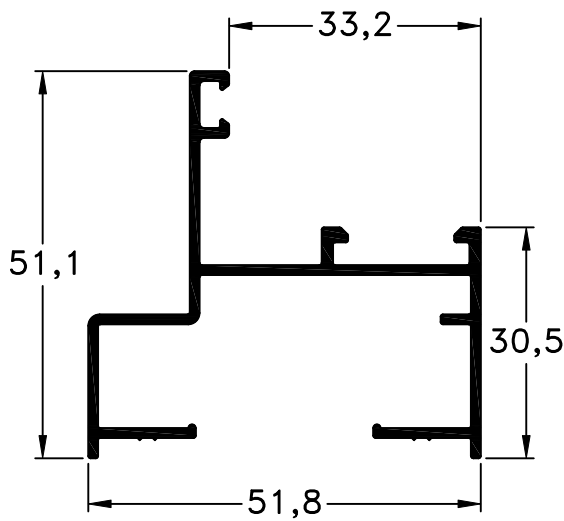

75 - Marco Paño Fijos y  
Ventana Doble Contacto  
Largo Std.: 6150 mm  
peso: 0,64 Kg/m

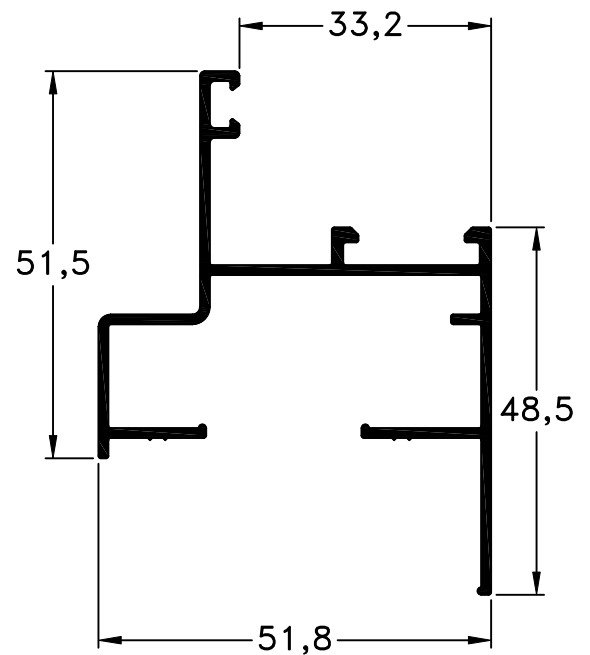

70 - Marco Paño Fijos y  
Ventana Doble Contacto  
Largo Std.: 6150 mm  
peso: 0,71 Kg/m

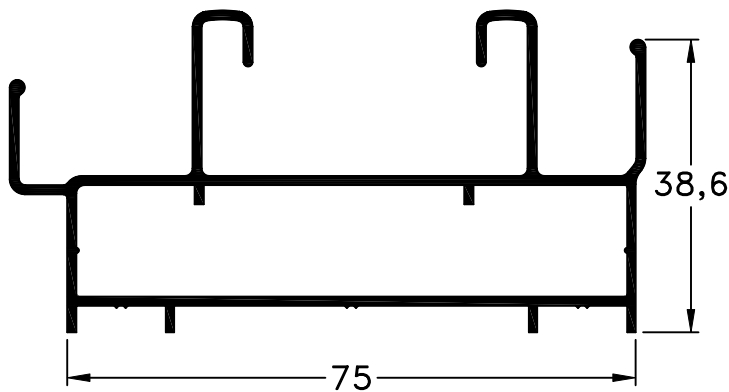

488 - Marco  
peso: 0,96 Kg/m

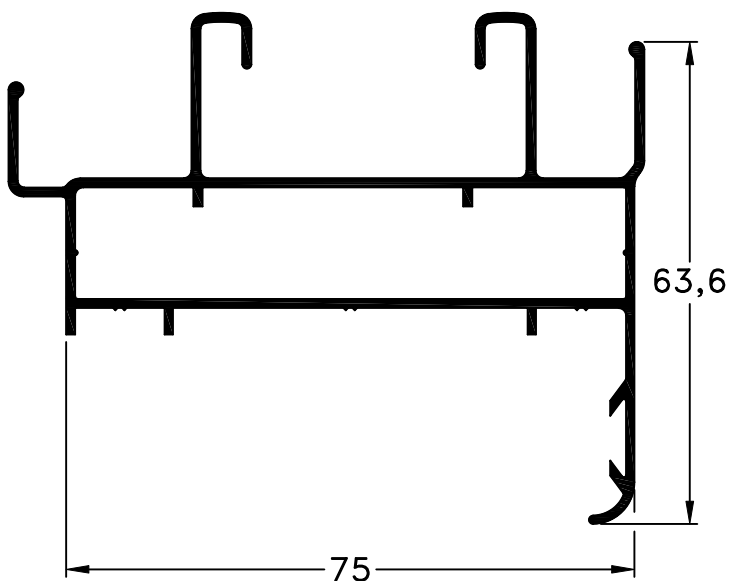

489 - Marco con  
Contramarco  
Largo Std.: 6300 mm  
peso: 1,06 Kg/m

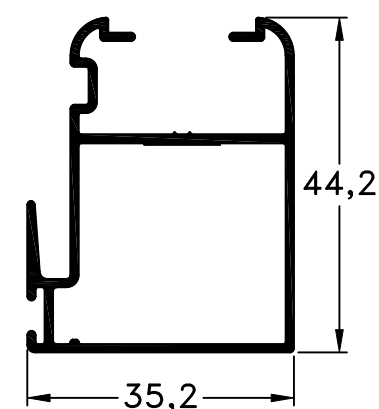
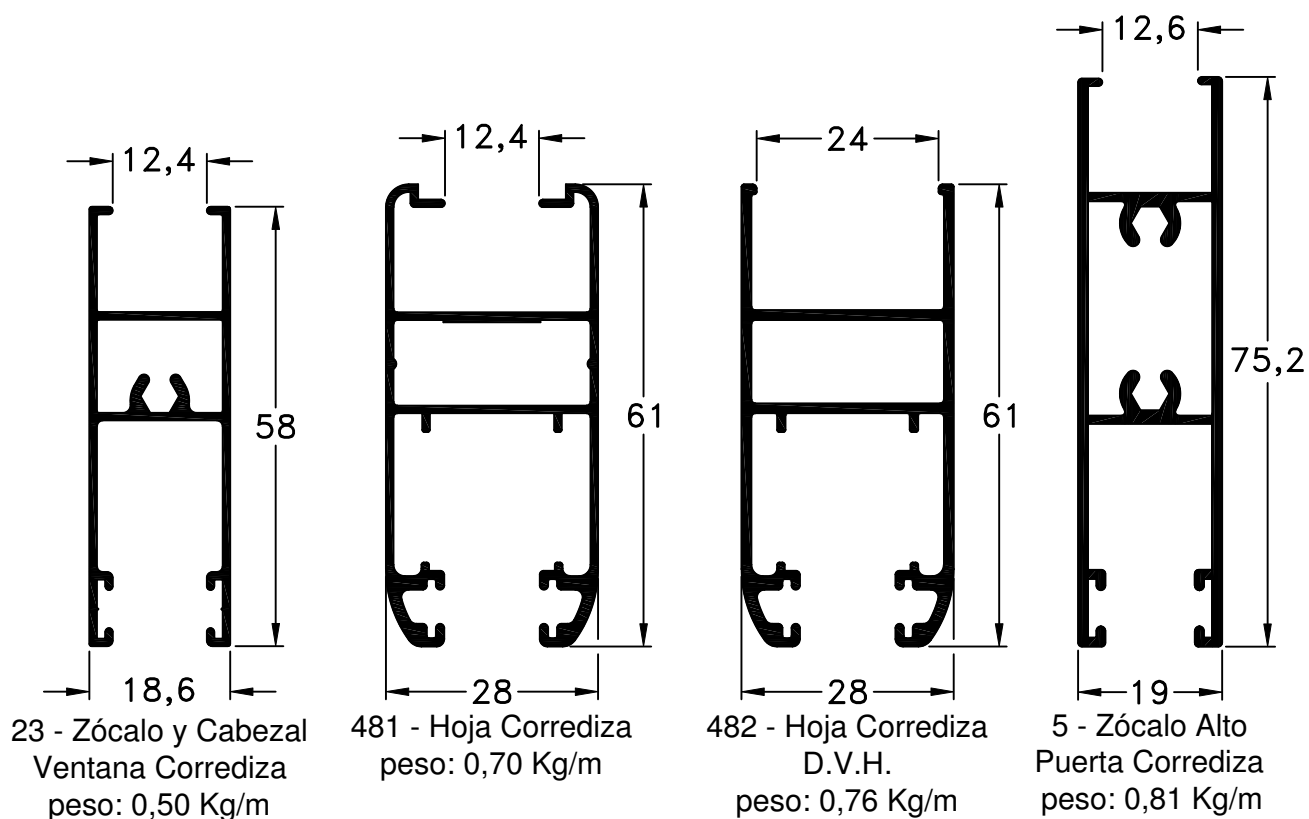

480 - Parante Central  
 v/p Corrediza  
 peso: 0,58 Kg/m

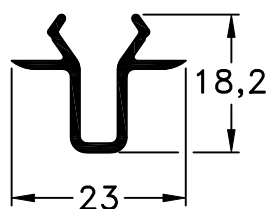

27 - Encuentro 4 Hojas  
 para Perfil 481 y 482  
 peso: 0,18 Kg/m

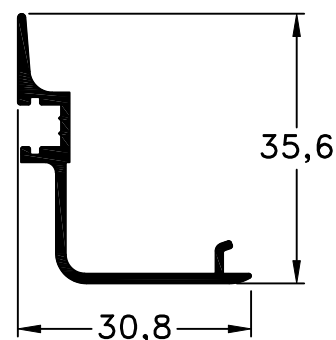

26 - Encuentro Hoja  
 peso: 0,27 Kg/m

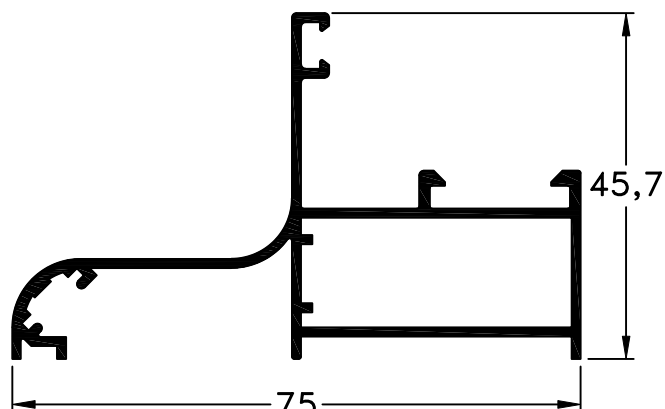

516 - Marco  
Largo Std.: 6150 mm  
peso: 0,76 Kg/m

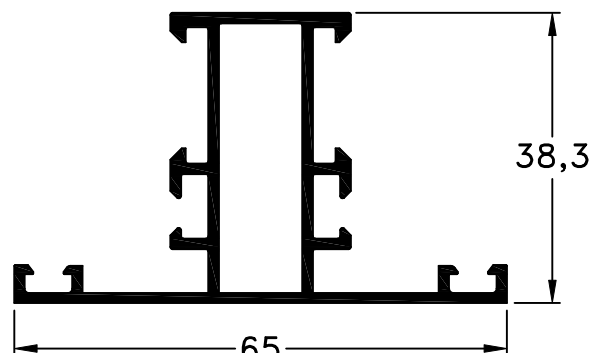

733 - Travesaño  
peso: 0,81 Kg/m

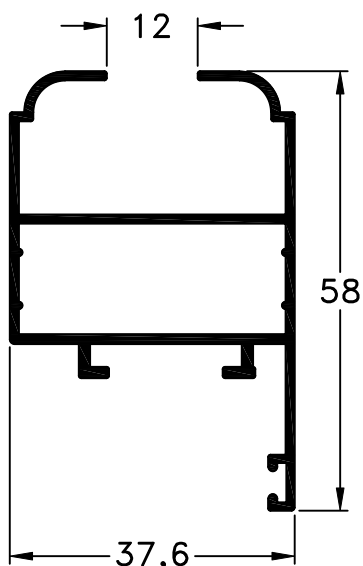

20 - Hoja  
peso: 0,68 Kg/m

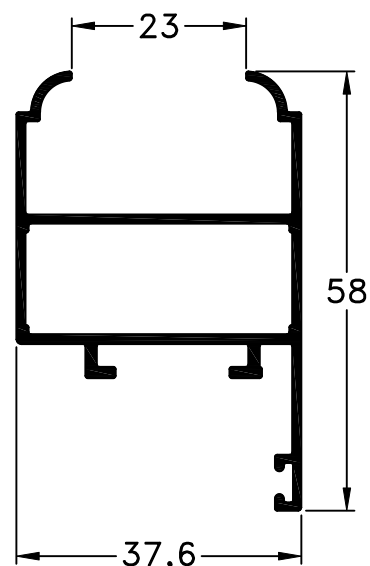

21 - Hoja  
peso: 0,65 Kg/m

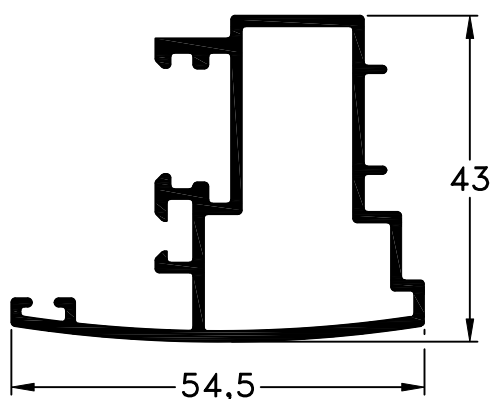

702 - Inversor Hoja  
peso: 0,81 Kg/m

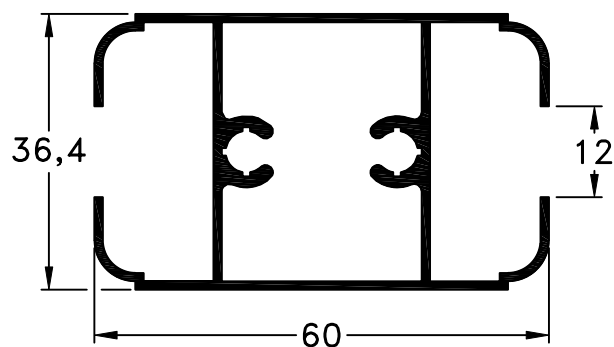

552 - Travesaño  
peso: 0,86 Kg/m

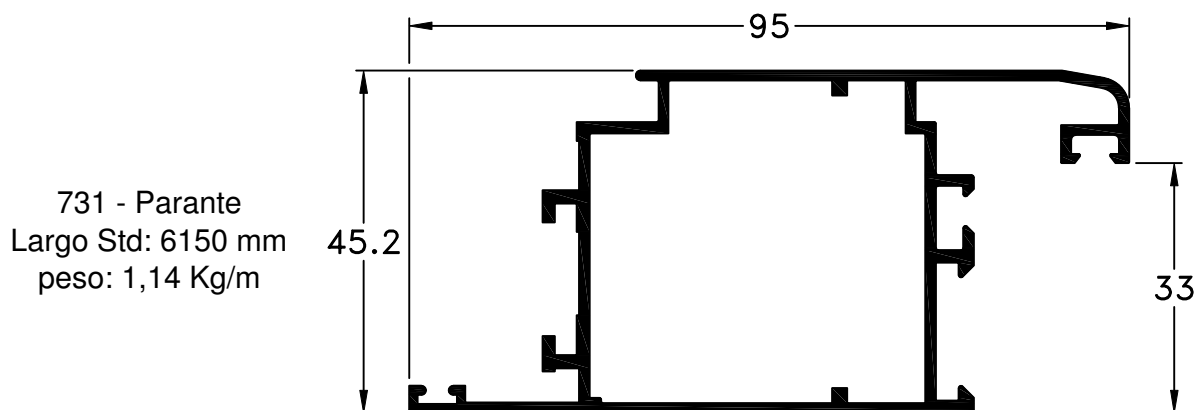
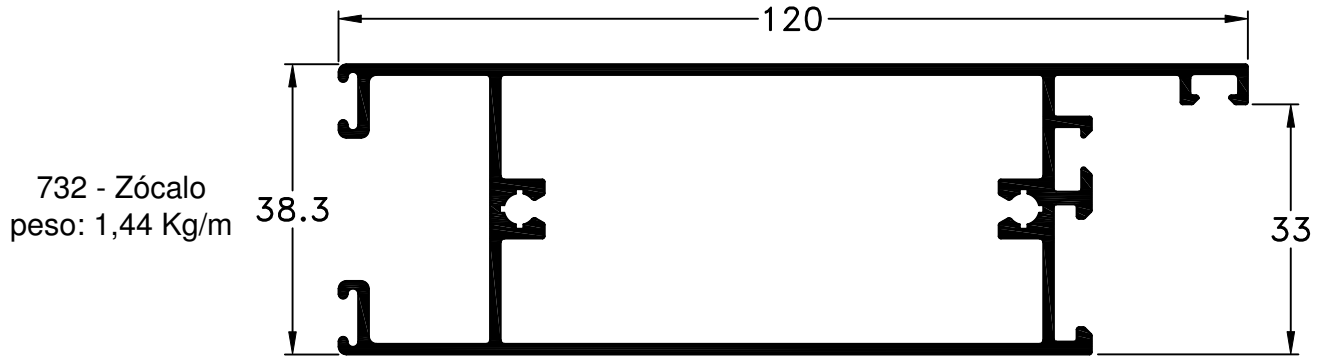
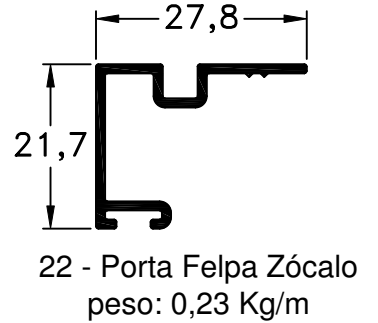
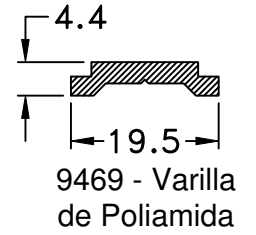
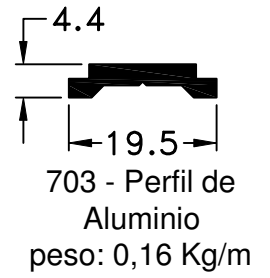
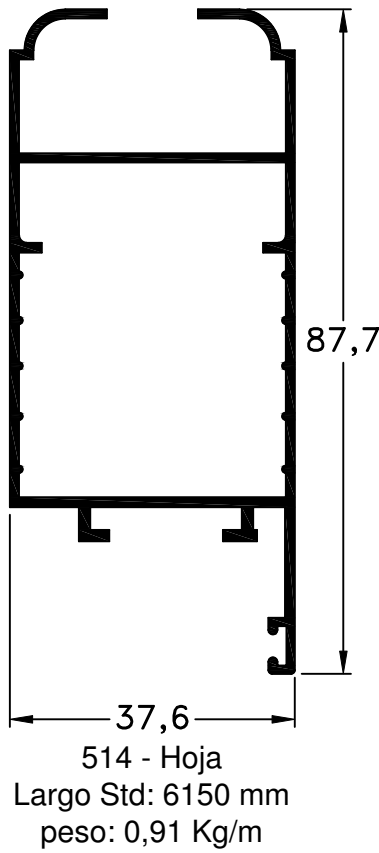
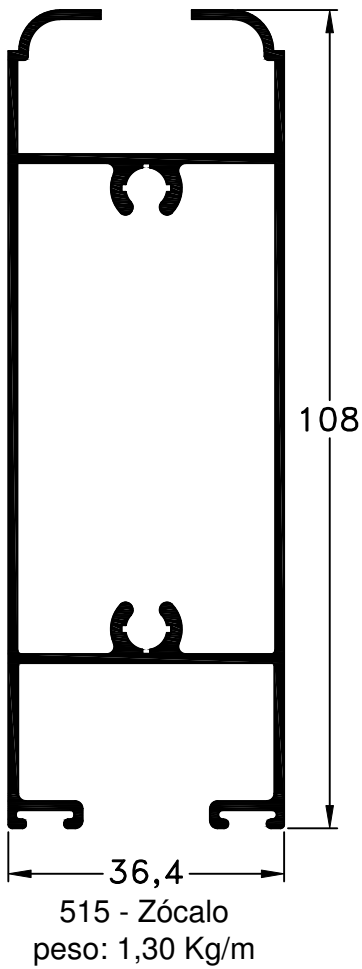

Escala 1:1  
Tolerancia en Peso +/- 10%

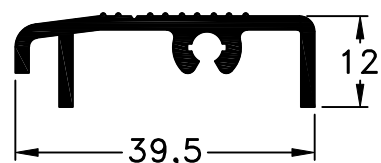

20-01-12 **GAMMA.8**

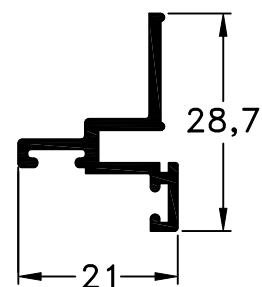

726 - Umbral Transitable  
peso: 0,39 Kg/m



725 - Tope Inferior Umbral  
peso: 0,26 Kg/m

Accesorios Adicionales para Puerta de Rebatir con Umbral Transitable, Perfiles 725 y 726				
Ítem	Código	Descripción	Forma	Cantidad
Cinta Adhesiva (Opción con Solia)	8999	Adhesivo Acrílico de 3M (1/2 pulgada)		1A
Burlete Hermetic. (Opción con Solia)	8906	Burlete AEL europeo		1A

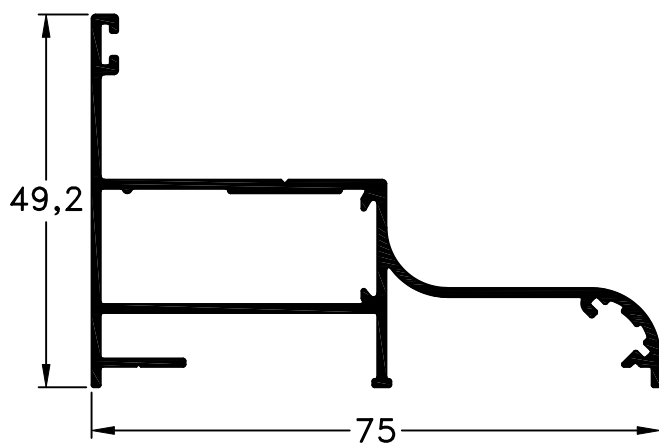

485 - Marco  
peso: 0,77 Kg/m

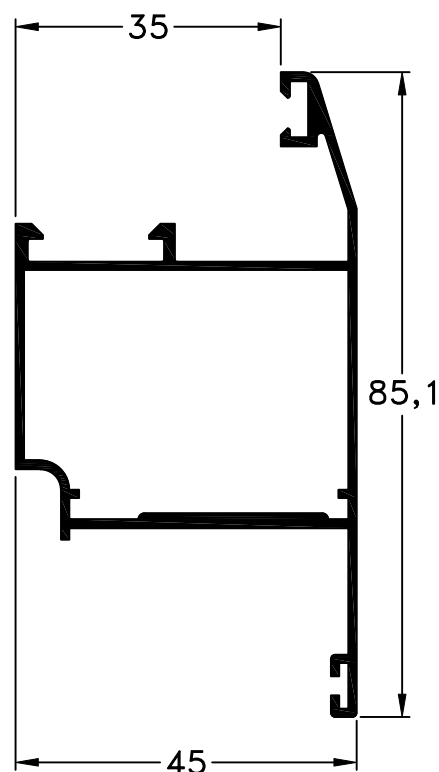

737 - Hoja  
peso: 0,83 Kg/m

Escala 1:1

Tolerancia en Peso +/- 10%

20-01-12 **GAMMA.9**

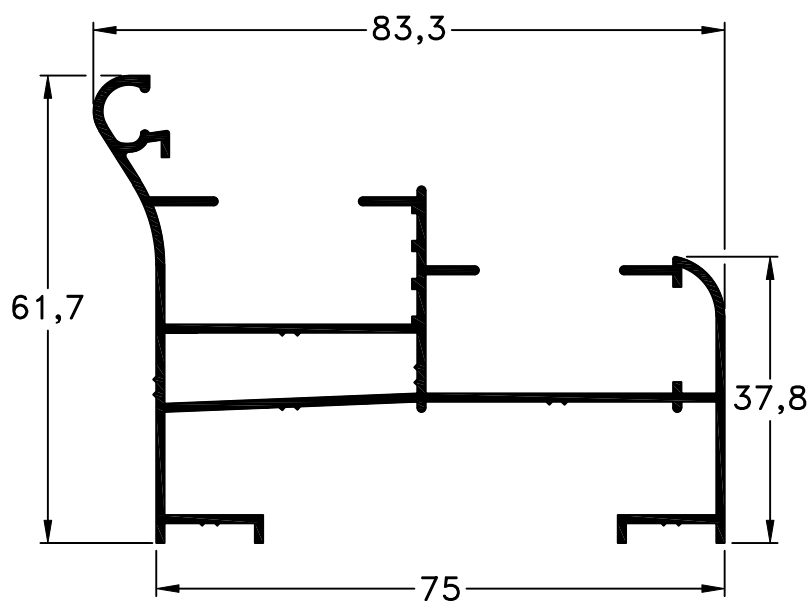

505 - Marco Ventana Guillotina  
peso: 0,97 Kg/m

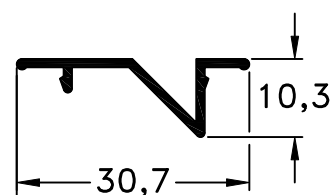

509 - Tapa  
peso: 0,14 Kg/m

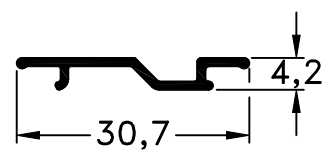

129 - Tapa Doble  
Compensador  
peso: 0,12 Kg/m

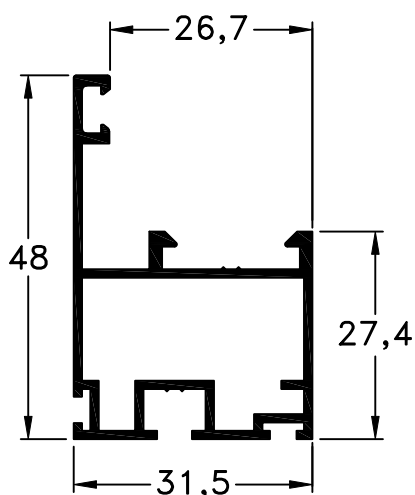

507 - Hoja  
peso: 0,56 Kg/m

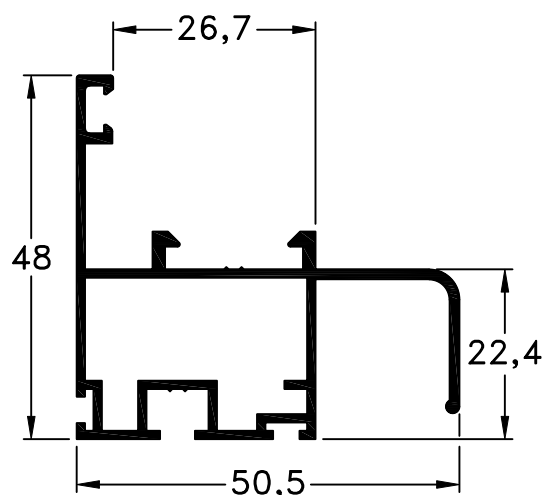

506 - Zócalo/Cabezal  
peso: 0,69 Kg/m

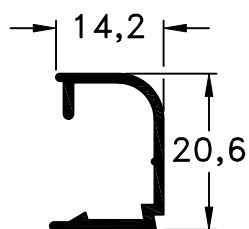

508 - Contravidrio  
V/S Guillotina  
peso: 0,17 Kg/m

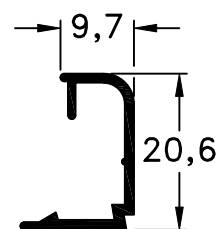

510 - Contravidrio  
D.V.H. Guillotina  
peso: 0,15 Kg/m

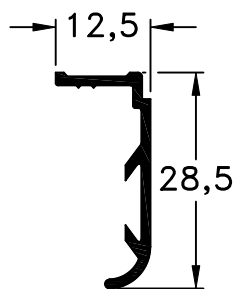

487 - Contramarco  
Largo Std.: 6150 mm  
peso: 0,17 Kg/m

Accesorios Contramarco 487				
Ítem	Código	Descripción	Forma	Cantidad
Esc. de Alineación	8919	Esc. Contramarco E-66		4 Unidades
Tornillos Autoperforantes o Remaches				s/m

s/m: según medida.

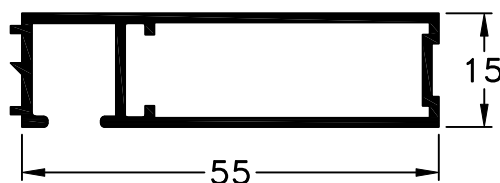

648 - Premarco  
Largo Std.: 6150 mm  
peso: 0,50 Kg/m

Dimensiones de Corte Premarco 648		
Cant.	Largo	Corte
2	A+36	45° 45°
2	H+36	45° 45°

Accesorios Premarco				
Ítem	Código	Descripción	Forma	Cantidad
Esc. de Armado	8723	Escuadra para Premarco 648 E-78		4 Unidades
Taco de Regul.	8927	Taco de Regulación T-88, para Perfiles de Marco 488, 489 y 516		
Tornillo	-	Tornillo de Fijación		s/m
Tapa Tornillo	8945	Tapa Cabeza de Tornillo T-95		s/m
Grampa	8722	Grampa de Amure		s/m
Esquinero	8724	Escuadra Esquinera de Premarco		4 Unidades

s/m: según medida.

Escala 1:1

Tolerancia en Peso +/- 10%

20-01-12 **GAMMA.11**

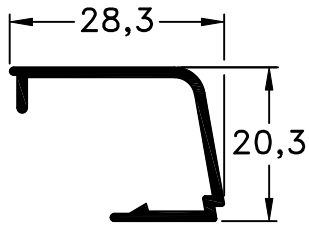

380 - Contravidrio  
peso: 0,22 Kg/m

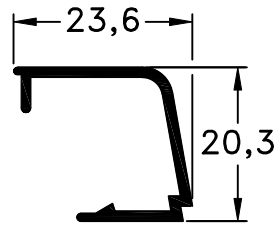

698 - Contravidrio  
peso: 0,20 Kg/m

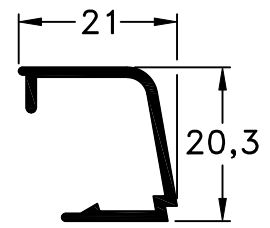

706 - Contravidrio  
peso: 0,20 Kg/m

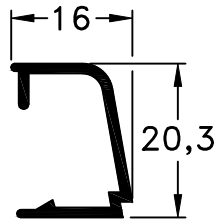

523 - Contravidrio  
peso: 0,17 Kg/m

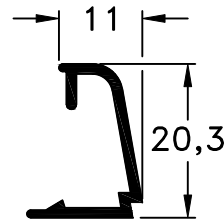

705 - Contravidrio  
peso: 0,16 Kg/m

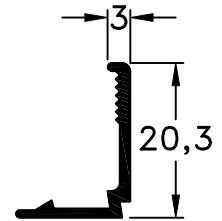

699 - Contravidrio  
peso: 0,13 Kg/m

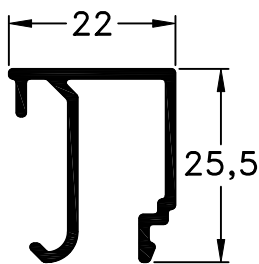

877 - Contravidrio  
peso: 0,30 Kg/m

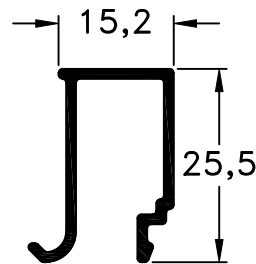

878 - Contravidrio  
peso: 0,25 Kg/m

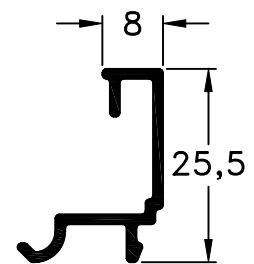

879 - Contravidrio  
peso: 0,21 Kg/m

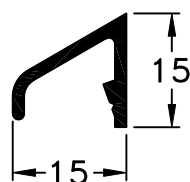

200 - Bota-Agua  
peso: 0,15 Kg/m

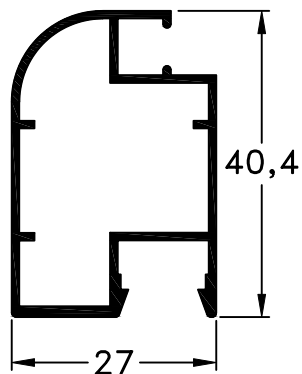

109 - Mosquitero  
peso: 0,44 Kg/m

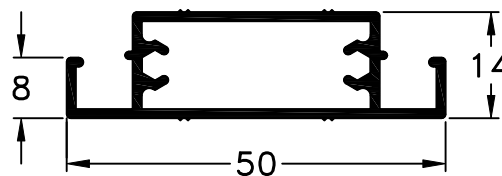

190 - Travesaño  
de Mosquitero  
peso: 0,45 Kg/m

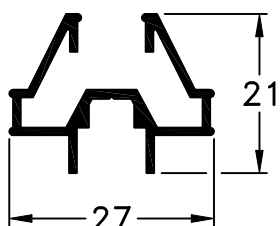

470 - Perimetral  
peso: 0,27 Kg/m

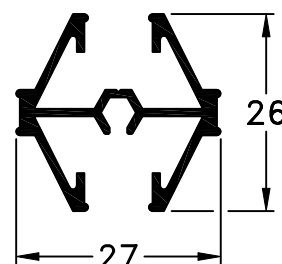

471 - Travesaño  
peso: 0,36 Kg/m

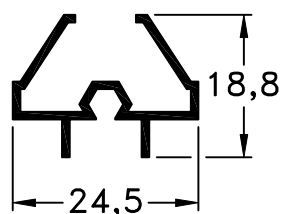

570 - Perimetral  
peso: 0,20 Kg/m

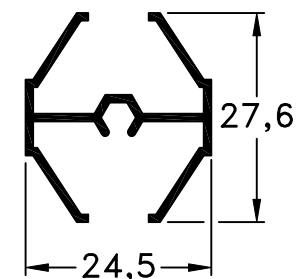

571 - Travesaño  
peso: 0,27 Kg/m

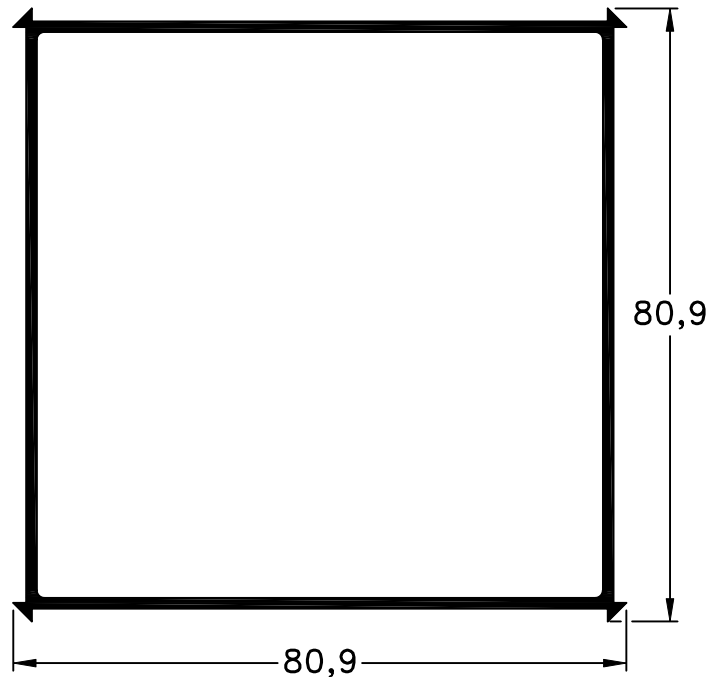

455 - Perfil Columna  
peso: 1,18 Kg/m

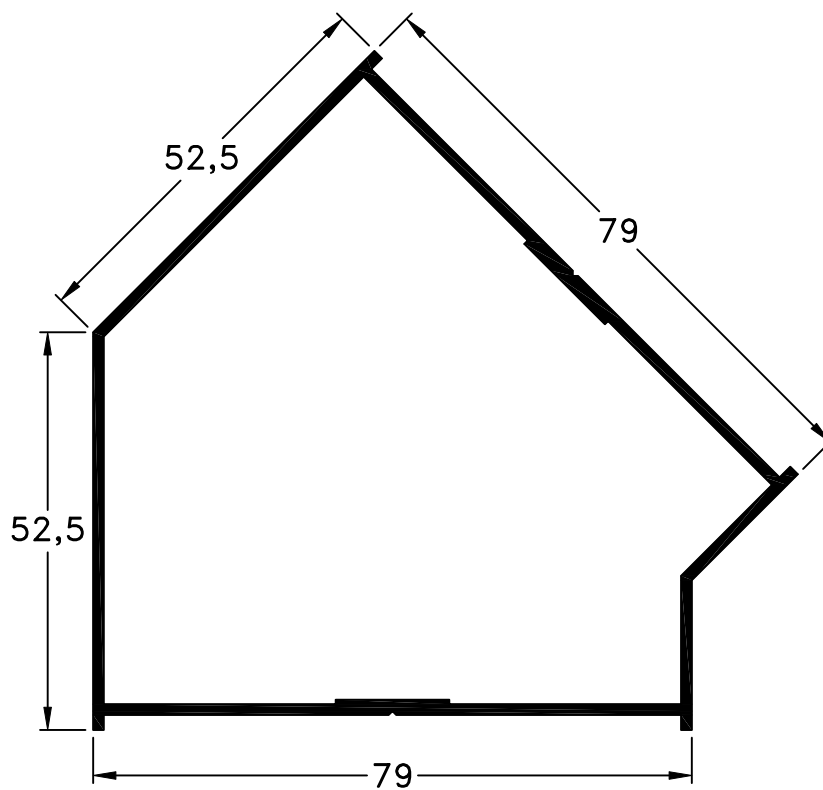

43 - Columna Recta  
peso: 1,17 Kg/m

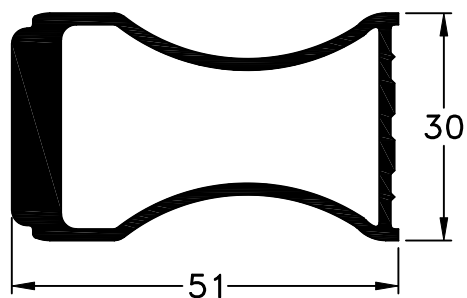

518 - Tirador  
peso: 1,00 Kg/m

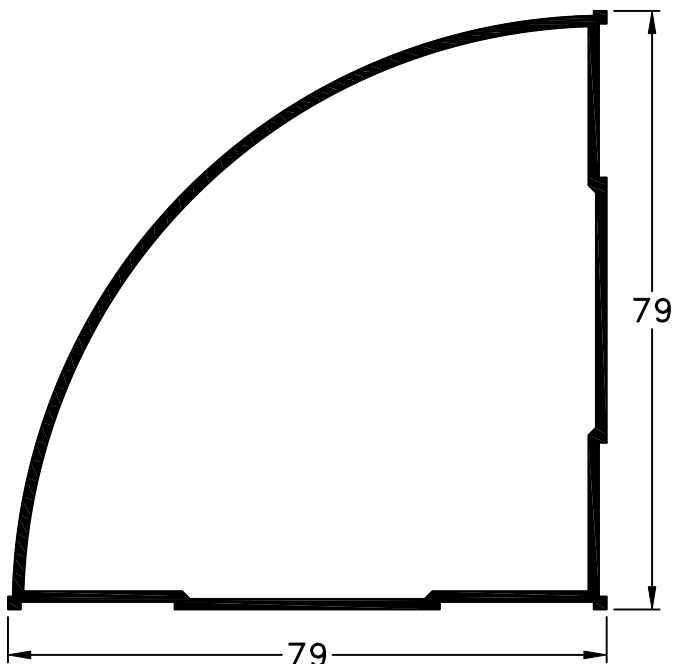

986 - Columna Curva  
peso: 1,06 Kg/m

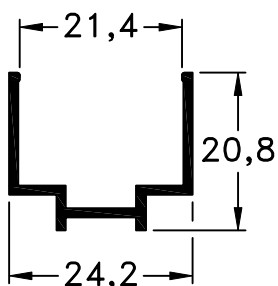

553 - Adaptador D.V.H.  
peso: 0,21 Kg/m

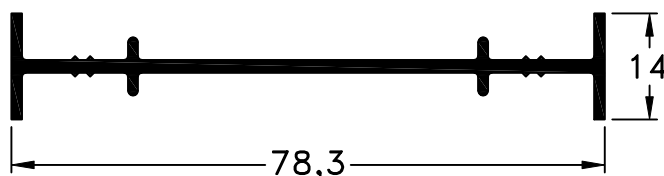

453 - Acople  
peso: 0,45 Kg/m

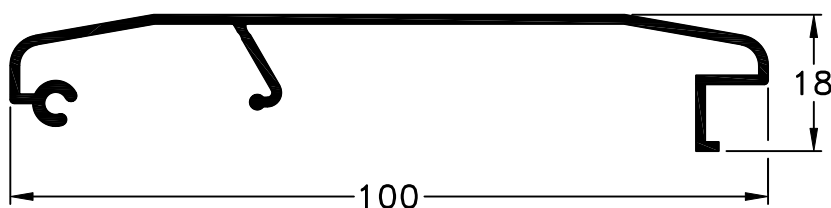

716 - Tapacinta  
Largo Std.: 6150 mm  
peso: 0,52 Kg/m

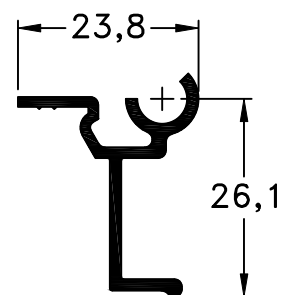

750 - Soporte Tapacinta  
Largo Std.: 6150 mm  
peso: 0,28 Kg/m

- Guías de Cortina para aplicar sobre Premarco 648

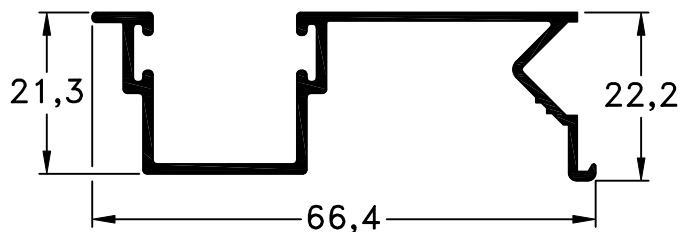

722 - Guía de Cortina Común  
Largo Std.: 6150 mm  
Peso: 0,49 Kg/m

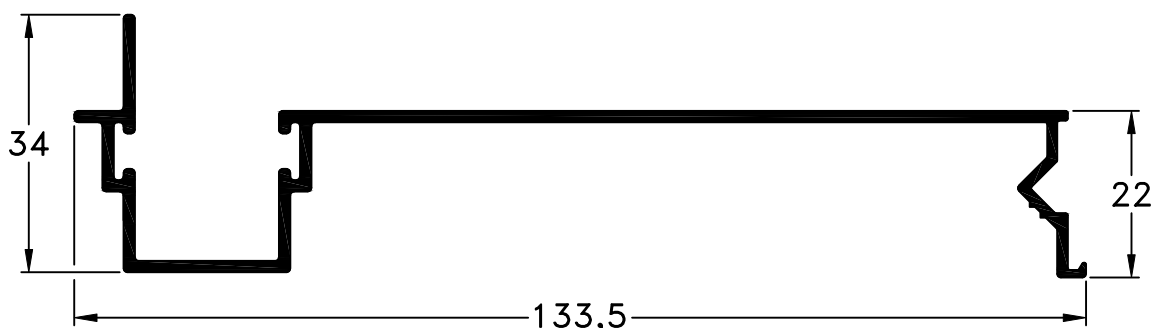

684 - Guía de Cortina Regulable  
Largo Std.: 6150 mm  
Peso: 0,89 Kg/m