

Vista

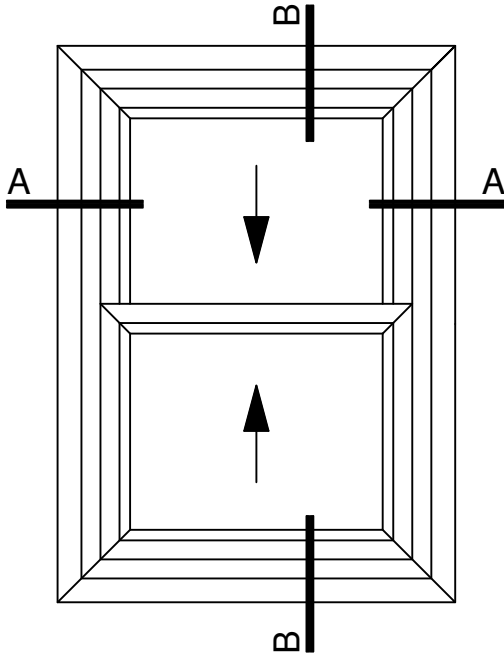

B-B Corte Vertical

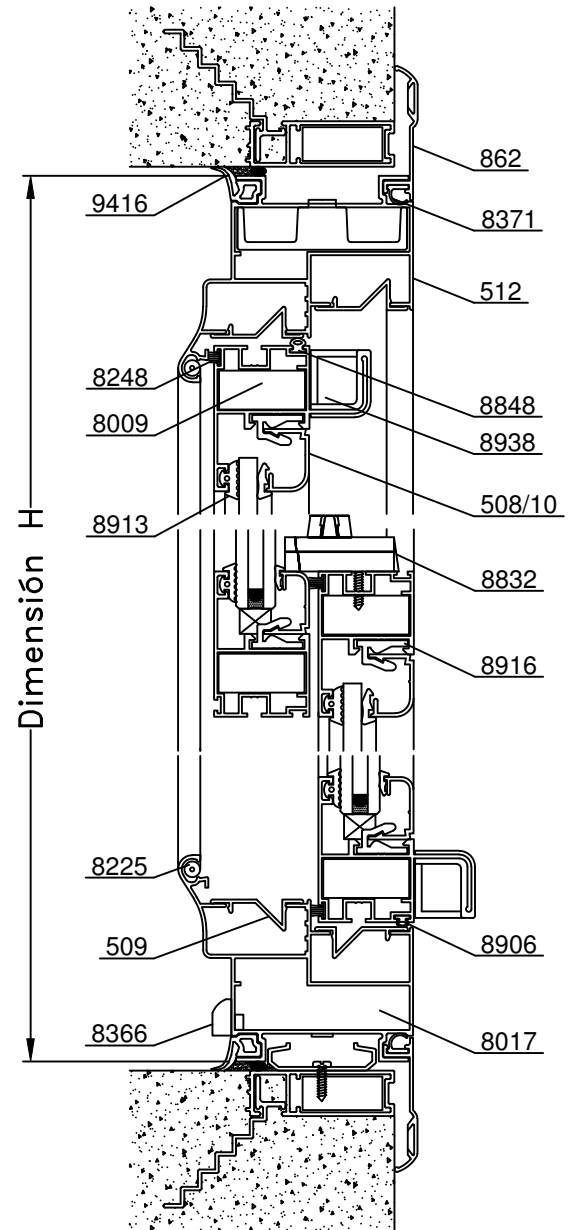

Nota:

Existen medidas máximas y mínimas a saber (Ver tabla de compensadores):

Ancho(A):

Mínimo 480 mm
Máximo: 1200 mm

Alto (H):

Mínimo: 860 mm
Máximo: 1500 mm

Nota:

Existe una alternativa de Cierre Central Coplanar, para las situaciones en las que no es posible utilizar el Cierre Convencional

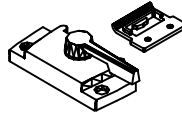

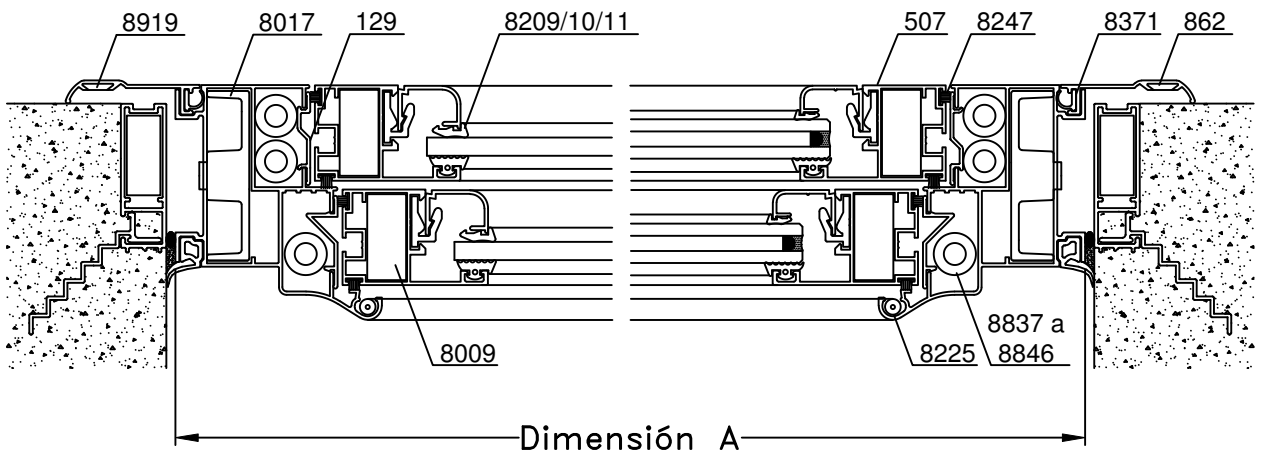

A-A Corte Horizontal



Escala 1:2.5

Tolerancia en Peso +/- 10%

















20-01-12 **MEDITERRANEA.48**

Dimensiones de Corte							
Código	Peso Kg/m	Forma	Función	Cant.	Largo	Corte	
512	1,05		Marco	2	A	45° 45°	
				2	H	45° 45°	
506	0,69		Zócalo / Cabezal	1	A-92	45° 45°	Hoja Interna
				1	A-110	45° 45°	Hoja Externa
507	0,56		Hoja	1	A-92	45° 45°	Hoja Interna
				1	A-110	45° 45°	Hoja Externa
				4	H/2-28	45° 45°	Hoja Interna / Externa
508 (V.S.) 510 (D.V.H.)	-	-	Contra - Vidrio	2	A-147	45° 45°	Hoja Interna
				2	A-165	45° 45°	Hoja Externa
				4	H/2-82	45° 45°	Hoja Interna / Externa

Dimensiones de Corte Contramarco: pág. 30

* Medidas en milímetros

Dimensiones de Corte Premarco: pág. 31

Detalle de Accesorios				
Ítem	Código	Descripción	Forma	Cantidad
Esc. de Armado	8017	Esc. de Armado Mediterranea E21-1		4 Unidades
	8009	Escuadra Hoja de Guillotina		8 Unidades
Clip	8916	Clip Contravidrios T-96		s/m
Tapón Lateral	8938	Tapón Lateral		4 Unidades
Burlete Vidrio	8913	Burlete de Acristalamiento B-68		4A + 2H
Cuña Vidrio	8209	Cuña Chica		4A + 2H
	8210	Cuña Mediana		
	8211	Cuña Grande		
Burlete Exterior	9416	Burlete Exterior Tapa de Sellado		2A + 2H
Felpa	8247	Felpa de Polipropileno 5x5		2H
	8248	Felpa de Polipropileno 5x7		3A + 2H
Burlete Hermetic.	8848	Burlete de Hermeticidad GUA-162		1A
	8906	Burlete AEL europeo		1A
Cierre Central	8832	Cierre Central Guillotina		1 Unidad
Cierre Lateral	8833	Cierre Lateral Guillotina		2 Pares
Patín Lateral	8834	Patín Lateral		2 Pares
Barra Pivot	8835	Barra Pivot		2 Pares
Tapa Desagüe	8366	Tapa Desagüe T-69		2 Unidades
Compensadores	8837 / 46	Compensadores H-118 (13'' a 31'')		2 Pares

s/m: según medida

Accesorios Contramarco: pág. 30 Accesorios Premarco: pág. 31